



FOURIERS

PASSION 2019 DRIVES INNOVATION



PASSION DRIVES INNOVATION.

Fouriers Bicycle Components is an exceptional Taiwanese manufacturing company. Behind Fouriers is a family firm of engineers and riders with a passion for bicycles and more than 20 years experience in developing and manufacturing high-end bike components. Fouriers was created with the intention to share our experience and passion with the rest of the world, in the hope that everybody can enjoy the sport.

QUALITY SAFETY PERFORMANCE.

We use the strongest and lightest materials for our components. Durable grades of aluminum, highest quality carbon fiber, and quality plastic imported from Switzerland. Fouriers is a world class manufacturer, and we rely on our sponsored riders to prove our ability to continuously develop and fabricate top tier bicycle components.

We Ride all bike types.

We Invest in our people, machines and riders.

We Discover new ideas and improve on others.

We Engineer every product from sketch to manufacturing.

We Refine existing products from good to excellent.

***Fouriers
For U Riders***

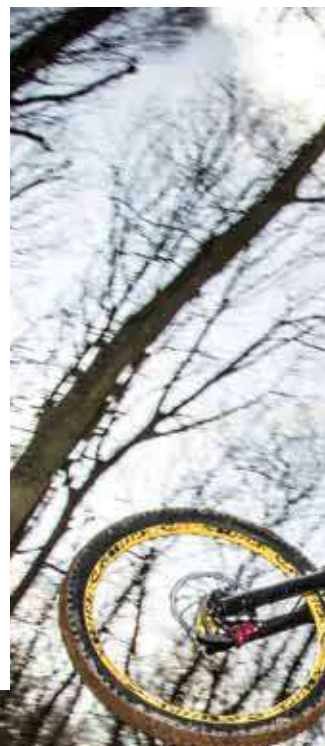
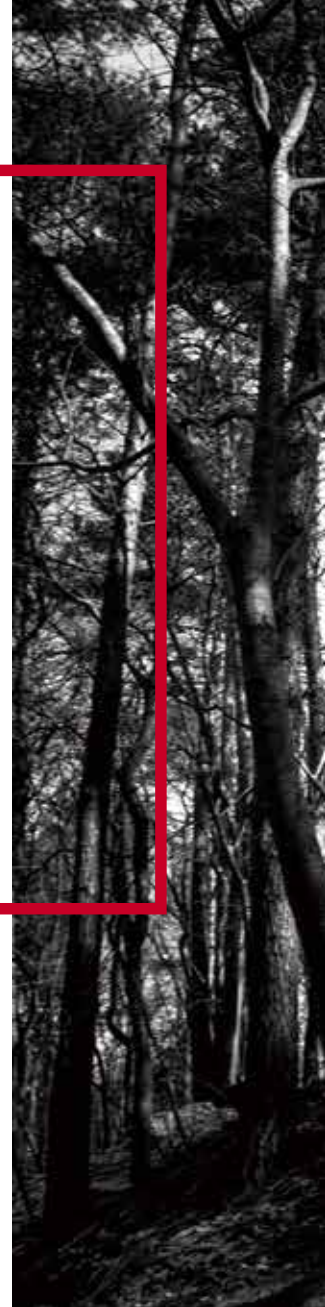



FOURIERS



- 08 | ROAD HANDLEBAR
- 10 | MTB HANDLEBAR
- 13 | INTEGRATED DI2 CABLE SYSTEM
- 14 | STEM
- 16 | BRAKE SYSTEM
- 18 | DISC ROTOR & ADAPTER
- 21 | SEATPOST
- 22 | CRANKSET & BB SYSTEM
- 24 | CHAINRING
- 28 | CHAIN CATCHER
- 29 | CHAIN GUARD
- 30 | ROLLER KIT
- 32 | QUICK RELEASE
- 33 | DI2 JUNCTION SPACER
- 34 | COMPUTER MOUNT
- 38 | TRIATHLON BAR
- 42 | GRIP & BAR TAPE
- 44 | SEAT CLAMP
- 45 | HEADSET & SPACER
- 46 | TOP CAP
- 47 | VALVE CAP & BOLT
- 48 | VALVE EXTENDER
- 49 | ACCESSORIES
- 50 | PROTECTION
- 51 | TOOL

POWER METER



CK-SHM110-PM

Material: Arm Carbon fiber
Axle AL7075-T651
Chainring AL7075-T651 full CNC made
BB: BSA 30, SHIMANO® Press Fit
Axle: 30mm
Length: 165 / 167.5 / 170 / 172.5 / 175 / 177.5mm
Chainring: double speed: 34-50T/ 36-52T/ 39-53T
Color: UD Carbon
Weight: 723g (39T-53T)

***Quantify your output to
exceed your inner potential***



CK-ATAC-PM

Material: Arm AL2024-T6
Axle AL7075-T651
Chainring AL7075-T651 full CNC made
BB: BSA 30, SHIMANO® Press Fit
Axle: 30mm
Length: 170 / 175mm
Chainring : 34 / 36 / 38T
Color: Anodize Black
Weight: 822g (36T)

ROAD HANDLEBAR

Avoid discomfort during riding and choose the handlebar that fits your needs.

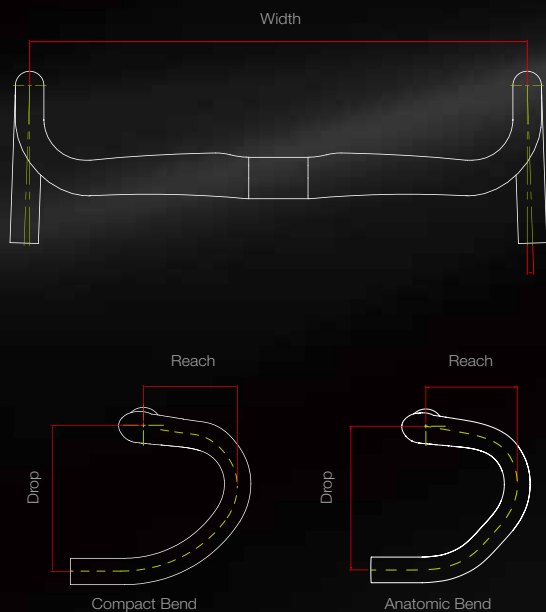

Item	Material	Spec	Drop	Reach	Rise	Width	Flare	Type
HB-RA001-N2	CARBON	Ø31.8	130	80	-	400 - 440	2°	Anatomic Bend
HB-RA002-N2	CARBON	Ø31.8	130	80	-	380 - 440	2°	Compact Bend
HB-RA003-N2	CARBON	Ø35	128	78	-	400 - 440	2°	Compact Bend
HB-RA004	7050	Ø35	145	80	-	380 - 440	2°	Anatomic Bend
HB-RA005	7050	Ø35	145	80	-	380 - 440	2°	Compact Bend
HB-RA006	7050	Ø31.8	130	85	-	380 - 440	2°	Anatomic Bend
HB-RA006-A6	6061	Ø31.8	130	85	-	380 - 440	2°	Anatomic Bend
HB-RA007	7050	Ø31.8	130	85	-	380 - 440	2°	Compact Bend
HB-RA007-A6	6061	Ø31.8	130	85	-	380 - 440	2°	Compact Bend
HB-RA008	7050	Ø31.8	130	80	-	380 - 440	2°	Anatomic Bend
HB-RA008-A6	6061	Ø31.8	130	80	-	380 - 440	2°	Anatomic Bend
HB-RA009-FL25	6061	Ø31.8	135	110	-	480 - 500	25°	Compact Bend
HB-RA010-FL12	6061	Ø31.8	130	80	-	380 - 440	12°	Compact Bend
HB-RA011-A6-E	6061	Ø31.8	125	80	15	360 - 420	2°	Compact Bend
HB-RA012-A6-T	6061	Ø31.8	125	75	-	320 - 420	2°	Compact Bend



Listen to your body, and choose the handlebar that suits your needs.

MTB HANDLEBAR

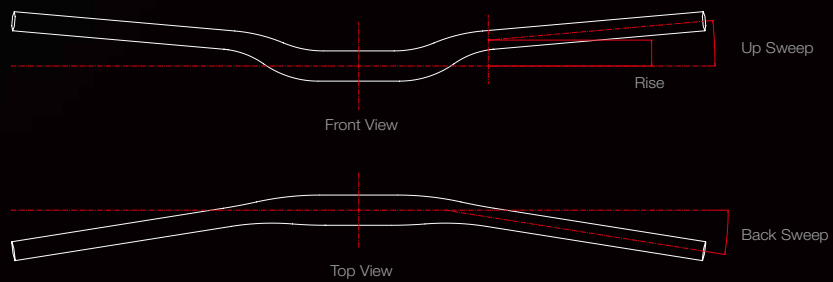

Item	Material	Spec	Back Sweep	Up Sweep	Rise	Eccentric	Width	Type
HB-MB001-N2	CARBON	Ø35	9°	5°	20 / 30	-	800	Riser Bar
HB-MB002-N2	CARBON	Ø31.8	9°	5°	20	-	800	Riser Bar
HB-MB003-N2	6066	Ø35	9°	5°	20	-	780	Riser Bar
HB-MB004-N2	6066	Ø31.8	9°	5°	20	-	780	Riser Bar
HB-MB007-N5	7050	Ø31.8	9°	-	-	5	720	Eccentric Bar
HB-MB007-N5-A6	6061	Ø31.8	9°	-	-	5	740	Eccentric Bar
HB-MB008-N5	CARBON	Ø31.8	9°	-	-	5	750	Eccentric Bar
HB-MB009-N2	6061	Ø31.8	5°	-	-	-	680	Flat Bar
HB-MB010-N2	7050	Ø31.8	5°	-	-	-	680	Flat Bar
HB-MB010-N2-H	7050	Ø31.8	5°	-	-	-	720	Flat Bar
HB-MB011-N2	6061	Ø31.8	9°	5°	20 / 25 / 30	-	720 / 780	Riser Bar
HB-MB012-N2	7050	Ø31.8	9°	5°	20 / 25 / 30	-	780	Riser Bar



HB-RA012-A6-T

Material: AL6061-T6
Spec: Ø31.8mm
Width: 320, 340, 360, 380, 400, 420mm
Drop: 125mm
Reach: 75mm
Bar Type: Compact bend
Weight: 300g (W420mm)
Color: S.B Anodized Black



HB-RA011-A6-E

Material: AL6061-T6
Spec: Ø31.8mm
Width: 360, 380, 400, 420mm
Drop: 125mm
Reach: 80mm
Rise: 15mm
Bar Type: Compact bend
Weight: 300g (W420mm)
Color: S.B Anodized Black



HB-RA001-N2

Material: Carbon fiber
Spec: Ø31.8mm
Width: 400, 420, 440mm
Drop: 130mm
Reach: 80mm
Bar Type: Anatomic bend
Weight: 225g (W420mm)



Pass EFBE test

EFBE
PRÜFTECHNIK

P1206089 / P1206090 / P1206091

HB-RA003-N2

Material: Carbon fiber
Spec: Ø35mm
Width: 400, 420, 440mm
Drop: 128mm
Reach: 78mm
Bar Type: Compact bend
Weight: 240g (W420mm)

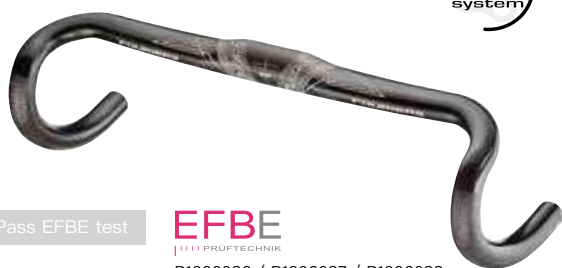

Pass EFBE test

EFBE
PRÜFTECHNIK

P1206086 / P1206087 / P1206088

HB-RA002-N2

Material: Carbon fiber
Spec: Ø31.8mm
Width: 380, 400, 420, 440mm
Drop: 130mm
Reach: 80mm
Bar Type: Compact bend
Weight: 225g (W420mm)



Pass EFBE test

EFBE
PRÜFTECHNIK

P1206089 / P1206090 / P1206091

HB-RA008 HB-RA008-A6

Material: AL6061-T6 / AL7050-T73
Spec: Ø31.8mm
Width: 380, 400, 420, 440mm
Drop: 130mm
Reach: 80mm
Bar Type: Compact bend
Weight: 285g (AL7050-T73 / W420mm)
320g (AL6061-T6 / W420mm)
Color: S.B Anodized Black



HB-RA009-FL25

It's made for touring and singletrack, special design offer 25 degrees flare in the drops, boosts comfortable and usability.

Material: AL6061-T6
Spec: Ø31.8mm
Width: 480, 500mm
Drop: 135mm
Reach: 110mm
Bar Type: Compact bend 25 degrees of flare
Weight: 340g (W480mm)
Color: S.B Anodized Black



HB-RA010-FL12

It's made for all condition, special design offer 12 degrees flare in the drops, boosts comfortable and usability.

Material: AL6061-T6
Spec: Ø31.8mm
Width: 380, 400, 420, 440mm
Drop: 130mm
Reach: 80mm
Bar Type: Compact bend 12 degrees of flare
Weight: 295g (W420mm)
Color: S.B Anodized Black



HB-RA004

Material: AL7050- T73
Spec: Ø35mm
Width: 380, 400, 420, 440mm
Drop: 145mm
Reach: 80mm
Bar Type: Anatomic bend
Weight: 265g (W420mm)
Color: S.B Anodized Black



HB-RA006 / HB-RA006-A6

Material: AL6061-T6 / AL7050-T73
Spec: Ø31.8mm
Width: 380, 400, 420, 440mm
Drop: 130mm
Reach: 85mm
Bar Type: Anatomic bend
Weight: 275g (AL7050-T73 / W420mm)
310g (AL6061-T6 / W420mm)
Color: S.B Anodized Black



HB-RA005

Material: AL7050-T73
Spec: Ø35mm
Width: 380, 400, 420, 440mm
Drop: 145mm
Reach: 80mm
Bar Type: Compact bend
Weight: 265g (W420mm)
Color: S.B Anodized Black



HB-RA007 / HB-RA007-A6

Material: AL6061-T6 / AL7050-T73
Spec: Ø31.8mm
Width: 380, 400, 420, 440mm
Drop: 130mm
Reach: 85mm
Bar Type: Compact bend
Weight: 275g (AL7050-T73 / W420mm)
310g (AL6061-T6 / W420mm)
Color: S.B Anodized Black



HB-MB001-N2

Material: Carbon fiber
Spec: Ø35mm
Width: 800mm
Rise: 20mm, 30mm
Back Sweep: 9°
Up Sweep: 5°
Weight: 295g



Pass EFBE test

EFBE
PROFTECHNIK

P1306487 / P1306488 / P1306489

HB-MB002-N2

Material: Carbon fiber
Spec: Ø31.8mm
Width: 800mm
Rise: 20mm
Back Sweep: 9°
Up Sweep: 5°
Weight: 280g



Pass EFBE test

EFBE
PROFTECHNIK

P1306490 / P1306491 / P1306492

HB-MB008-N5

Material: Carbon fiber
Spec: Ø31.8mm
Width: 750mm
Eccentric: 5mm
Back Sweep: 9°
Weight: 170g



HB-MB007-N5 HB-MB007-N5-A6

Material: AL7050-T73 / AL6061-T6
Spec: Ø31.8mm
Width: 720mm (7050) / 740mm (6061)
Eccentric: 5mm
Back Sweep: 9°
Weight: 235g (7050) / 330g (6061)
Color: S.B Anodized Black, Red, Gray



Pass EFBE test

EFBE
PROFTECHNIK

P1206022 / P1206023 / P1206024

HB-MB003-N2

Material: AL6066-T6
Spec: Ø35mm
Width: 780mm
Rise: 20mm
Back Sweep: 9°
Up Sweep: 5°
Weight: 428g
Color: S.B Anodized Black, Silver, Red, Gold, Gray



Pass EFBE test

EFBE
PRÜFTECHNIK

P1206028 / P126029 / P1206030

HB-MB004-N2

Material: AL6066-T6
Spec: Ø31.8mm
Width: 780mm
Rise: 20mm
Back Sweep: 9°
Up Sweep: 5°
Weight: 382g
Color: S.B Anodized Black, Silver, Red, Gold, Gray



Pass EFBE test

EFBE
PRÜFTECHNIK

P1206028 / P1206029 / P1206030

HB-MB009-N2

Material: AL6061-T6
Spec: Ø31.8mm
Width: 680mm
Back Sweep: 5°
Weight: 210g
Color: S.B Anodized Black, Red, Gold, Gray, Blue,
Apple Green, Orange, Purple, Pink, Ocean Blue



HB-MB010-N2-H

Material: AL7050-T73
Spec: Ø31.8mm
Width: 800mm
Back Sweep: 5°
Overload: 800kgs
Weight: 275g
Color: S.B Anodized Black, Red, Gold, Gray, Blue,
Apple Green, Orange, Purple, Pink, Ocean Blue



HB-MB010-N2

Material: AL7050-T73
Spec: Ø31.8mm
Width: 680mm
Back Sweep: 5°
Weight: 210g
Color: S.B Anodized Black



HB-MB016-CC

Fouriers' Control Curve Technology comes to life in this triple butted, eccentric handlebar. The control curve bend at the hand grip area functions as an arch support for the hands. Riders benefit from less hand fatigue and great comfort in all riding positions, creating confident control.

Material: AL7050-T73
Spec: Ø31.8mm
Width: 760 / 800mm
Back Sweep: 9°
Eccentric: 5mm
Weight: 260g (W800mm)
Body: S.B Anodized Black
Sticker: Red, Gray, Apple Green



HB-MB017-M HB-MB017-A6-M

The "Trailhead Handlebar" is a utilitarian and trekking handlebar that will take you to the trailhead and beyond. Featuring a comfortable sweep for enduring rides, while giving additional leverage and more control. The control curve bend at the hand grip area functions as an arch support for the hands. Riders benefit from less hand fatigue and great comfort in all riding positions.

Material: AL7050-T73 / AL6061-T6
Spec: Ø31.8mm
Width: 720mm
Back Sweep: 35°
Rise: 20mm
Weight: 289g (7050) / 334g (6061)
Body: S.B Anodized Black
Sticker: Red, Gray, Apple Green



HB-MB011-N2

Material: AL6061-T6
Spec: Ø31.8mm
Width: 720 / 780mm
Back Sweep: 9°
Up Sweep: 5°
Rise: 20, 25, 30mm
Weight: 280g (720mm) / 375g (780mm)
Color: S.B Anodized Black, Red, Gold, Gray, Blue, Apple Green, Orange, Purple, Pink, Ocean Blue



HB-MB012-N2

Material: AL7050-T73
Spec: Ø31.8mm
Width: 780mm
Back Sweep: 9°
Up Sweep: 5°
Rise: 20, 25, 30mm
Weight: 375g
Color: S.B Anodized Black





STASHKING INTEGRATED DI2

COMPATIBLE SHIMANO®
DI2 SYSTEM

Integrated wire ports make StashKing,
the King of clean lines.

HB-SC002-DI2

Unique DI2 compatible carbon flat handlebar.

Material: Carbon fiber
Spec: Ø31.8mm
Width: 780mm
Back Sweep: 9°
Eccentric: 5mm
Weight: 169g



HB-SA001-DI2

Unique DI2 compatible alloy flat handlebar.

Material: AL6061-T6
Spec: Ø31.8mm
Width: 720mm
Back Sweep: 7°
Eccentric: 5mm
Weight: 235g
Color: S.B Anodized Black



SM-MB108-DI2

Unique stem for SHIMANO® MTB DI2 system.
Features an integrated cable system inside the stem for a
clean looking bike.

Material: AL6061-T6 full CNC made
Bar-Bore: Ø31.8mm
Fork Tube: Ø28.6mm
Fork Stack Height: 40mm
Angle: -17°
Length: 80 - 140mm
Weight: 215g/set (90mm)
Color: Anodized Black





SM-MB115-MT6

A stunning MTB stem integrated cycling computer mount. Compatible shape can compatible with GARMIN Edge® & MIO® & Bryton®.

Material: AL6061-T6 full CNC made
 Clamp: Ø31.8
 Fork Tube: Ø28.6
 Fork Stack Height: 35.5mm
 Angle: -6°
 Length: 80 - 120mm
 Weight: 186g (100mm)
 Color: Anodized Black
 Comes with top cap

SM-MB007

Good for Enduro.

Material: AL6066-T6 full CNC made / Titanium bolts
 Handlebar Clamp: Ø31.8mm
 Fork Tube: Ø28.6mm
 Fork Stack Height: 40mm
 Angle: 0°
 Length: 45mm
 Weight: 144g
 Color: Anodized Black, Gray



SM-MB113-G0

Good for Enduro.

Material: AL6066-T6 full CNC made / Titanium bolts
 Handlebar Clamp: Ø31.8mm
 Fork Tube: Ø28.6mm
 Fork Stack Height: 34.5mm
 Angle: 0°
 Length: 35mm
 Weight: 103g
 Color: S.B Anodized Black



SM-MB001

Loud and proud, our SM-MB001 stem is looking to get wild, good for Enduro.

Material: AL6066-T6 full CNC made
 Handlebar Clamp: Ø35mm
 Fork Tube: Ø31.8mm
 Fork Stack Height: 40mm
 Angle: 0°
 Length: 50mm
 Weight: 205g
 Color: Anodized Black, Gray



SM-DH001

The DH Direct Mount stem.

Material: AL6066-T6 full CNC made
 Direct Mount: Boxxer
 Handlebar Clamp: Ø35mm
 Offset height: 17.3mm
 Weight: 92g
 Color: S.B Anodized Black, Gray



SM-MB002

Material: AL6066-T6 full CNC made
 Handlebar Clamp: Ø35mm
 Fork Tube: Ø31.8mm
 Fork Stack Height: 40mm
 Angle: 0°
 Length: 40mm
 Weight: 140g/set
 Color: Anodized Black



SM-MB003

The DH Direct Mount stem.

Material: AL6066-T6 full CNC made
 Offset Height: 25mm
 Handlebar Clamp: Ø35mm
 Weight: 171g
 Color: Anodized Black, Gray





SM-MB114-G17 / SM-MB114-G25

A stunning MTB stem designed to be stiff and unique shape. -17° / -25 degree low rise, and length start from 80-120mm.

Material: AL6061-T6 full CNC made
 Handlebar Clamp: Ø31.8
 Fork Tube: Ø28.6
 Fork Stack Height: 28mm
 Angle: -17° / -25°
 Length: 80 - 120mm
 Weight: 206g (100mm)
 Color: Anodized Black

SM-RA001

Extreme lightweight full CNC made stem. Cut out of one aluminum 6066 block to improve overall strength and anti-corrosion.

Material: AL6066-T6 full CNC made / Titanium bolts
 Handlebar Clamp: Ø35mm
 Fork Tube: Ø31.8mm
 Fork Stack Height: 40mm
 Angle: ±8°
 Length: 80 - 140mm
 Weight: 145g (100mm)
 Color: Anodized Black



Pass EFBE test

EFBE
 PROFTECHNIK

P1306487 / P1306488 / P1306489

SM-RA002

Extreme lightweight full CNC made stem.

Material: AL6066-T6 full CNC made / Titanium bolts
 Handlebar Clamp: Ø31.8mm
 Fork Tube: Ø28.6mm
 Fork Stack Height: 40mm
 Angle: ±6°
 Length: 80 - 140mm
 Weight: 133g (100mm)
 Color: Anodized Black



Pass EFBE test

EFBE
 PROFTECHNIK

P1306490 / P1306491 / P1306492

SM-RA009

Cut out of one aluminum 6066 block to improve overall strength and anti-corrosion. Stem has ±17 degree angle.

Material: AL6066-T6 full CNC made / Titanium bolts
 Handlebar Clamp: Ø31.8mm
 Fork Tube: Ø31.8mm
 Fork Stack Height: 40mm
 Angle: ±17°
 Length: 80 - 140mm
 Weight: 153g (100mm)
 Color: Anodized Black



SM-RA010

Material: AL6061-T6 3D forged
 Handlebar Clamp: Ø31.8mm
 Fork Tube: Ø28.6mm
 Fork Stack Height: 40mm
 Angle: ±7°, ±17°
 Length: 60 - 130mm
 Weight: 152g (100mm)
 Color: S.B Anodized Black



SM-MB109-G7

Material: AL6061-T6 3D forged
 Handlebar Clamp: Ø31.8mm
 Fork Tube: Ø28.6mm
 Fork Stack Height: 40mm
 Angle: ±7°
 Length: 70 - 110mm
 Weight: 150g (100mm)
 Color: S.B Anodized Black



SM-MB110-G0

Material: AL6061-T6 3D forged
 Handlebar Clamp: Ø31.8mm
 Fork Tube: Ø28.6mm
 Fork Stack Height: 40mm
 Angle: ±0°
 Length: 35, 45, 55, 65mm
 Weight: 118g (45mm)
 Color: S.B Anodized Black





BR-DX005

Applicable for GIANT® PROPEL 2017 and older versions.
Direct mount aero V-brake / Linear spring adjustment system
Quick width switch for different rim width comes with SWISS STOP® brake shoes.

Material: AL6066-T6 full CNC made
Weight: 215g/bike
Color: Anodized Black



BR-DX006

Fits GIANT® NEW TRINITY.
Direct mount aero v-brake.
Liner spring adjustment system.
Use Swiss Stop brake pad for alloy wheel.

Material: AL6066-T6 Full CNC made
Weight: 275g/bike
Color: Anodized Black

BR-S005

Applicable for GIANT® PROPEL 2017 and older versions.
Direct mount aero V-brake / Linear spring adjustment system
Quick width switch for different rim width.

Material: AL6061-T6 3D forged
Weight: 230g/bike
Color: S.B Anodized Black



BR-DX001

Extreme lightweight full CNC caliper brake. The use of leverage allows this brake to use a single-axis design for reduced weight and balanced braking power. With a titanium bolt and SWISS STOP® brake shoe.

Material: AL6066-T6 full CNC made
Brake Shoes: CNC cassette
Bolt: Main bolt Ti-64
Dimension: C-C 39-51mm
Weight: 210g/bike
Color: Anodized Black, Silver, Red, Gold, Gray



BR-S003

Extreme lightweight caliper brake. The use of leverage allows this brake to use a single-axis design for reduced weight and balanced braking power.

Material: AL6066-T6 forged made
Brake Shoes: Forged cassette
Bolt: Main bolt Cr-Mo
Dimension: C-C 39-51mm
Weight: 245g/bike
Color: Anodized Black, Silver, Red, Gold, Gray



BR-S006

Route your existing brake cable and housing from your current drop levers through these ergonomic lever. Allows you to control your speed from multiple hand positions. Can be used independently. Split clamp for easy installation. Adjustable reach and return spring. Canti or caliper compatibility. With Ø24mm shim.
Design by TOKYO SAN-ESU

Material: AL6061-T6 forged
For: Ø31.8 handlebar
Weight: 128g/pair
Color: S.B Anodized Black



BR-S001

Spring power is adjustable for a more balanced braking power. For cyclo-cross.

Material: AL6061-T6
Weight: 205g/bike
Color: S.B Anodized Black, Silver, Red



BR-DX003

Light weight design V-brake lever.
Fits SHIMANO® standard brake cable.

Material: AL6066-T6 full CNC made
Spe: Ø24mm (with Ø22.2 shim)
Weight: 70g/pair
Color: Anodized Black, Red



BR-DX004

For Caliper-brake lever, Canti-brake lever, Mini V-brake lever
fits SHIMANO® standard brake cable.

Material: AL6066-T6 full CNC made
Spe: Ø24mm (with Ø22.2 shim)
Weight: 85g/pair
Color: Anodized Black, Red



BR-E001

Compatible with SHIMANO® caliper system.
Adjustable angle with curve washer.

Material: AL6066-T6 full CNC made
Weight: 59g/bike
Color: Anodized Black, Silver, Red



BR-E006

Compatible with SHIMANO® caliper system.
Adjustable angle with curve washer.

Material: AL6066-T6
Weight: 71g/bike
Color: Anodized Black, Silver, Red



BR-E007

Compatible with SHIMANO® caliper system.
Adjustable angle with curve washer.

Material: AL6066-T6
Weight: 70g/bike
Color: Anodized Black, Silver, Red



BR-E008

Replacement pad cartridges.

Rims: Aluminum, Carbon
Fits: SHIMANO® & SRAM® / Campagnolo®
Weight: 13g/wheel



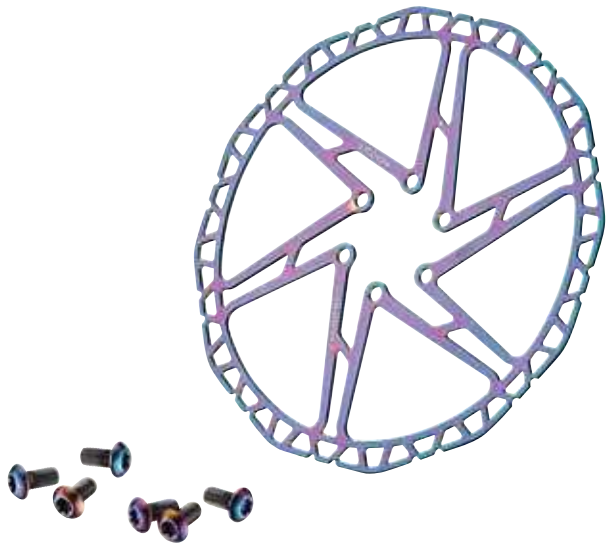

BR-D1P-2

Disc brake rotor. Compatible with the international standard 6 hole (IS mount).

Material: Stainless steel
 OD Size: Ø140, Ø160, Ø180, Ø203mm
 Thickness: 1.7mm
 Color: Ti-Coating

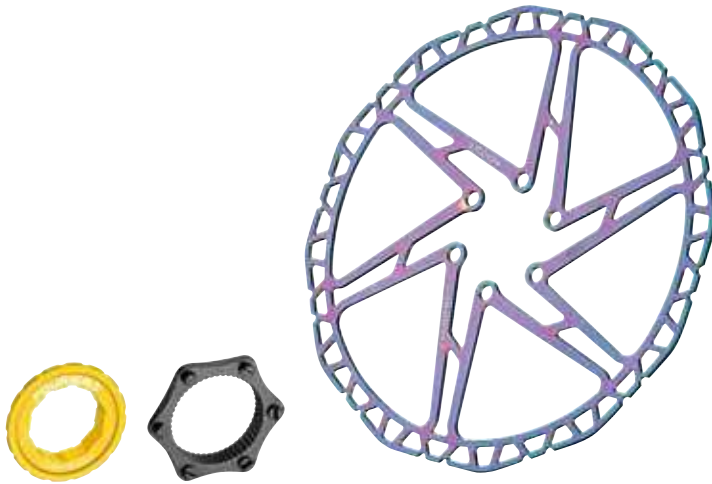

BR-D1P-2-LK

Disc brake rotor. Compatible with center lock system.

Material: Stainless steel rotor,
 AL6061-T6 adapter and lock ring
 Stainless steel washer
 OD Size: Ø140, Ø160, Ø180, Ø203mm
 Thickness: 1.7mm
 Color: Ti-Coating rotor, S.B Anodized Black adapter
 S.B Anodized Gold lock ring

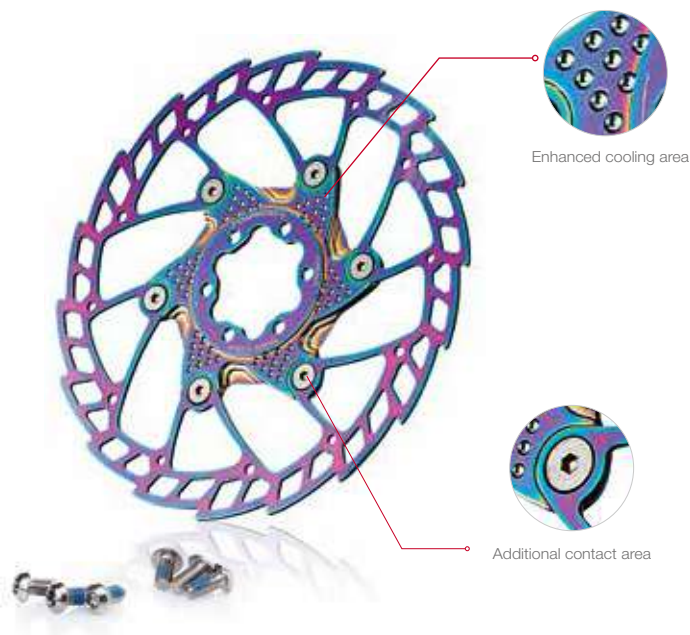
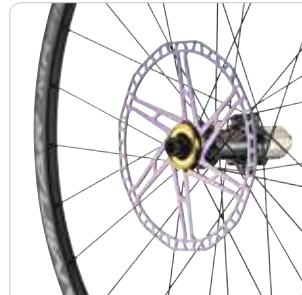

BR-DSK001

Two piece brake rotor, functionally designed with heat dissipating "dimple" surface. Stainless steel disc with AL6061 carrier piece.
 Compatible with the international standard 6 hole (IS mount).

Material: Stainless steel disc
 AL6061-T6 CNC made body
 OD Size: Ø140, Ø160, Ø180, Ø203mm
 Weight: 136g/pcs (Ø180mm)
 Thickness: 1.7mm
 Color: Ti-coating

ADP-DISC-SH

SHIMANO® center lock disc hub adaptor. Change center lock disc hub to the international 6 bolt standard disc.

Material: AL6061-T6 body and lock ring
Stainless steel washer
Weight: 25g/set
Body Color: S.B Anodized Black, Silver

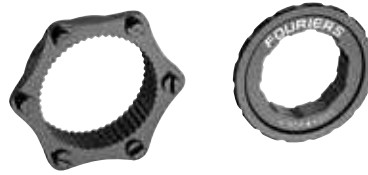

ADP-DISC-SH-BF

Center Lock System.
Front Ø15mm 100mm hub change to boost 110mm hub.

Material: AL6061-T6 body and lock ring
Stainless steel washer
Color: Anodized Black
Weight: 35g/set



ADP-DISC-SH-BR

Center Lock System.
Rear Ø12mm 142mm hub change to boost 148mm hub.

Material: AL6061-T6 body and lock ring
Stainless steel washer
Color: Anodized Black
Weight: 31g/set



ADP-DISC-BF501

Front Ø15 100mm hub change to boost 110mm hub.

Material: AL6061-T6 full CNC made
Weight: 11g/set (without screws)
Color: Anodized Black



ADP-DISC-BR301

Rear Ø12mm 142mm hub change to boost 148mm hub.

Material: AL6061-T6 full CNC made
Weight: 11g/set (without screws)
Color: Anodized Black



ADP-PM001

Adapter to mount larger disc brake rotor.
Fits 74mm post mount caliper and post mount fork.

Material: AL6061-T6 CNC made
Post Moun: 74mm
Spec: 140mm to 160mm / 160mm to 180mm
Weight: 11g/pcs
Color: S.B Anodized Black, Red, Gray



ADP-PM002

Adapter to mount larger disc brake rotor.
Fits 74mm post mount caliper and post mount fork.

Material: AL6061-T6 CNC made
Post Moun: 74mm
Spec: 160mm to 203mm
Weight: 23g/pcs
Color: S.B Anodized Black, Red, Gray





SP-S001 SP-S001-DI2

Extreme lightweight carbon seatpost with one piece monocoque construction. Includes our carbon top clamp design. It's the best choice to reduce road vibrations. Double bolt clamp design for easy angle adjustment. 20mm offset, best used for Road.

Material: UD Carbon fiber, Carbon clamp
Spec: Ø27.2, Ø30.9, Ø31.6mm
Length: 400mm
Offset: 20mm
Weight: 240g (Ø31.6/400mm)

Pass EFBE test

EFBE
 PRÜFTECHNIK



P1206092 / P1206093
 Pass overload 300kg



SP-S003 SP-S003-DI2

Extreme lightweight full carbon seatpost with one piece monocoque construction. Includes our carbon top clamp design. Best choice to shave off weight. Double bolt clamp design for easy angle adjustment. Has no offset, best used for MTB.

Material: UD Carbon tube, Carbon clamp
Spec: Ø27.2, Ø30.9, Ø31.6mm
Length: 400mm
Offset: 0mm
Weight: 235g (Ø31.6/400mm)



Please follow instructions on the warning sticker before tightening carbon clamp



SP-DX001

Extreme lightweight full CNC aluminum seatpost. Great aesthetics and unique design. Double bolt clamp design for easy angle adjustment. Has no offset, best used for MTB.

Material: AL6066-T6 full CNC made
Spec: Ø27.2, Ø31.6mm
Length: 400mm
Offset: 0mm
Weight: 320g (Ø31.6/400mm)
Color: Anodized Black



SP-AG12

Durable, strong, and good looking 3D forged seatpost. Double bolt clamp design for easy angle adjustment. 12mm offset.

Material: 3D forged one-piece AL6061-T6 shaft
Spec: Ø27.2, Ø30.9, Ø31.6mm
Length: 400mm
Offset: 12mm
Weight: 345g (Ø31.6/400mm)
Color: S.B Anodized Black



CR-S002

Design to mount onto a 6 bolt disc-hub. This converts your bike into a fixed gear using the special adapter to fix on SHIMANO® cassette style hubs. The adapter is made from a lightweight alloy 6061-T6 disc.

Material: Cold forged Cr-Mo heat treated steel (ASM4140) and AL6061-T6 for the adapter
N.E.N finished cog / Red anodize adapter

Spec: Use for disc hub 6 hole and cassette hub

Teeth: 12T-23T

With lock ring x 1 pcs & 10mm x 1, 5mm x 1, 3mm x 3 Spacer



CR-S001

Complete cog and spacer kit for use with a SHIMANO-style freehub. Designed for quick single speed conversion, from a geared bike.

Material: Cold forged Cr-Mo heat treated steel (ASM4140)
N.E.N finished

Spec: For cassette hub

Teeth: 12T-23T

With lock ring x 1 pcs &

10mm x 1, 5mm x 2, 3mm x 3 Spacer



BB-S001

Fit PressFit 30 frame (Ø46mm x 68 / 73mm) to BB30 crankset (30mm axle). Enduro® bearings inside for top class quality.

Material: Plastic bearing cup, alloy side cover

Bearing: Enduro® sealed bearing

Weight: 83g

Product name	Product diameter		Frame bottom bracket diameter	
BB-S001-010	Ø46	+0.13	Ø46	+0.1
		+0.11		+0.06
BB-S001-005	Ø46	+0.08	Ø46	+0.05
		+0.06		+0.01
BB-S001-001	Ø46	+0.06	Ø46	+0.0
		+0.02		-0.05



TL-BB386

Precision CNC machined aluminum tool for the installation and removal of 16-notch external bearing bottom brackets.

Material: AL6061-T6 Full CNC made

Fix: FSA® MegaEVO® (16 notch 48.5mm OD cup)

Wheels® PF30 (16 notch 49.3mm OD cup)

Fouriers BSA30

Weight: 50g

Color: S.B Anodized Black



TECHNOLOGY IN THE CRANKSET



CK-SHM110

Our complete carbon crankset is simple, lightweight and extremely rigid. Featuring hollow blow molded arms and a 30mm spindle, our crankset will drive your maximum torque!

Material: Arm Carbon fiber
Axle AL7075-T651
Chainring AL7075-T651 full CNC made
BB: BSA 30, SHIMANO® Press Fit
Axle: 30mm
Length: 165 / 167.5 / 170 / 172.5 / 175 / 177.5mm
Chainring: double speed: 34-50T / 36-52T / 39-53T
Color: UD Carbon
Weight: 670g (34T-50T)



CK-ATAC

Full CNC machined oversized 30mm axle and versatile crank arms. ISO test passed. For MTB.

Material: Arm AL2024 -T6
Axle AL7075-T651
Chainring AL7075-T651 full CNC made
BB: BSA 30, SHIMANO® Press Fit
Axle: 30mm
Length: 170 / 175mm
Chainring: 34 / 36 / 38T
Color: Anodize Black
Weight: 822g (36T)



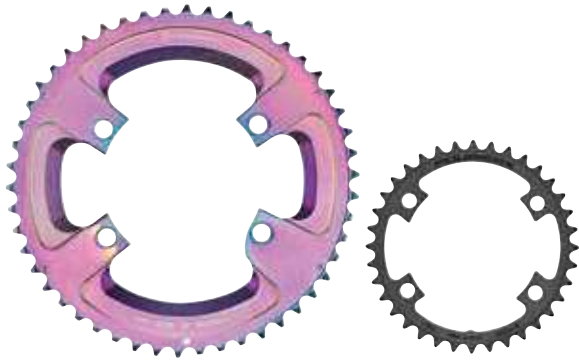

CR-SHM8000

Aircraft material and full cnc made high quality chainring, compatible with SHIMANO® FC-R8000 crankset. New design chainring gives smooth shifting and reliable quality.

Material: AL7075-T651 full cnc made

P.C.D: Ø110mm

Teeth: 34T & 50T, 36T & 52T, 39T & 53T

Weight: 29g/pcs (34T), 128g/pcs (50T)

Color: S.B Anodized Black, Red, Blue, Green,
Ti-coating for large chainring

ITEM	FIX CRANKSET	TEETH
CR-SHM8000	SHIMANO® FC-R8000	34T + 50T 36T + 52T 39T + 53T



CR-SHM110

Aircraft material and full cnc made high quality chainring, compatible with SHIMANO® crankset. New design chainring gives smooth shifting and reliable quality.

Material: AL7075-T651 full cnc made

P.C.D: Ø110mm

Teeth: 34T & 50T, 36T & 52T, 39T & 53T

Weight: 27g/pcs (34T), 134.5g/pcs (50T)

Color: S.B Anodized Black, Red, Blue, Green,
Ti-coating for large chainring

ITEM	FIX CRANKSET	TEETH
CR-SHM110-58	SHIMANO® FC-5800	34T + 50T 36T + 52T 39T + 53T
CR-SHM110-68	SHIMANO® FC-6800	
CR-SHM110-90	SHIMANO® FC-9000	

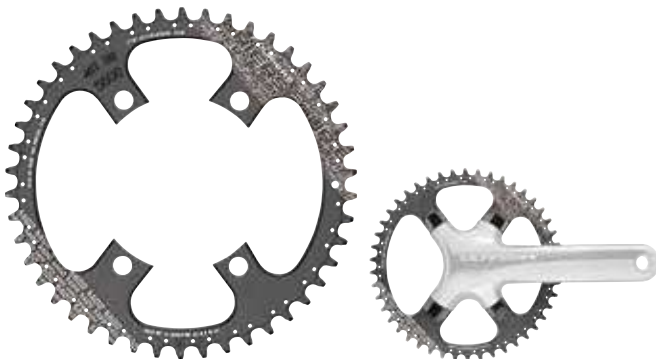

CR-DX5800-110 CR-DX6800-110

Narrow Wide chainrings for SHIMANO® FC5800 105 / FC- 6800 ULTEGRA crank set, the stepped profile of our snug fit wave design maintains excellent chain retention.

CNC details to each tooth, include a teardrop port for mud clearance. For 1X system P.C.D Ø110mm 4 arm standard.

Includes carbon with nylon cover cap to fit the SHIMANO® crankset.

Material: AL7075-T651

P.C.D: Ø110mm

Weight: 82g/pcs (40T)

Color: S.B Anodized Black, Red, Blue

ITEM	FIX CRANKSET	TEETH
CR-DX5800-110	SHIMANO® FC-5800	40T ~ 48T
CR-DX6800-110	SHIMANO® FC-6800	40T ~ 48T



CR-E1-DX5800-110 CR-E1-DX6800-110

Narrow Wide chainrings for SHIMANO® FC5800 105 / FC- 6800 ULTEGRA crank set. For 1X system P.C.D Ø110mm 4 arm standard.

Includes carbon with nylon cover cap to fit the SHIMANO® crankset.

Material: AL7075-T651

P.C.D: Ø110mm

Weight: 92g/pcs (40T)

Color: S.B Anodized Black, Red, Blue

ITEM	FIX CRANKSET	TEETH
CR-E1-DX5800-110	SHIMANO® FC-5800	40T ~ 48T
CR-E1-DX6800-110	SHIMANO® FC-6800	40T ~ 48T

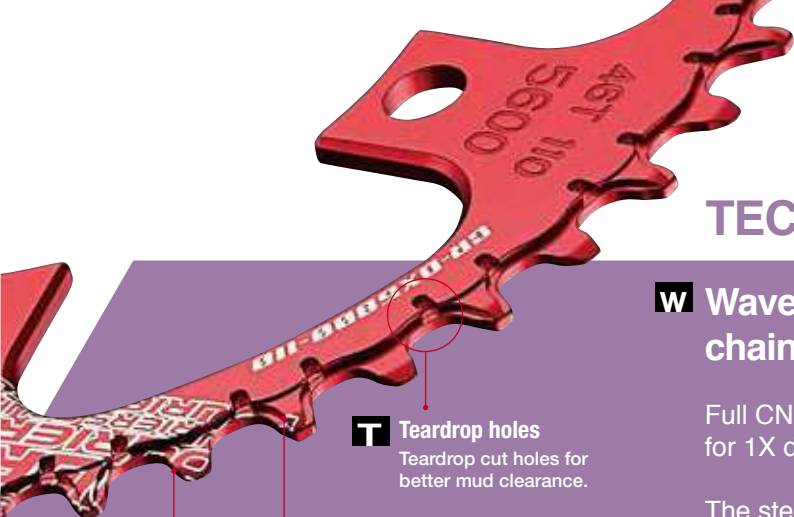

TECHNOLOGY - WAVE

W Wave shape profile on the chain side for snug fit.

Full CNC'd Narrow Wide Chainrings for 1X drivetrains.

The stepped profile of our snug fit wave design maintains excellent chain retention. CNC details to each tooth, include a teardrop port for mud clearance.

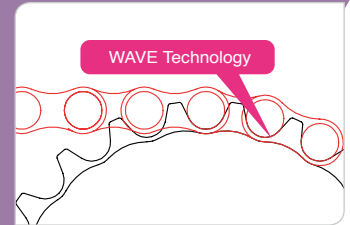

T Teardrop holes
Teardrop cut holes for better mud clearance.

N Narrow wide teeth
Alternating thick and thin shapes to tightly fit chainring.



CR-E1-R8000

Full CNC made narrow wide chainring for 1x system. Compatible with SHIMANO® FC-R8000 crankset.

Material: AL7075-T651
Weight: 78g/pcs (42T)
Color: S.B Anodize Black

ITEM	FIX CRANKSET	TEETH
CR-E1-R8000	SHIMANO® FC-R8000	40T ~ 48T



CR-DX8000 / CR-DX9000

Narrow Wide chainrings for XT M8000 11 speed / XTR-M9000 11 speed. With Narrow wide teeth, Teardrop holes, Wave Technology design.

Material: AL7075-T651
P.C.D: Ø96mm
Weight: 56g/pcs (36T)
Color: S.B Anodized Black, Red, Blue

ITEM	FIX CRANKSET	TEETH
CR-DX8000	SHIMANO® XT-M8000	30T ~ 36T
CR-DX9000	SHIMANO® XTR-M9000	30T ~ 36T



CR-DX8000-OV / CR-DX9000-OV

Narrow Wide Oval chainrings for XT M8000 11 speed / TR-M9000 11 speed crank Oval shape design make the spincycle a lot smoother and is easier on legs while climbing. Adjust the oval in 3 position to increase its effect. With Narrow wide teeth, Teardrop holes, Wave Technology design.

Material: AL7075-T651
P.C.D: Ø96mm
Weight: 96g/pcs (36T)
Color: S.B Anodized Black, Red, Blue

ITEM	FIX CRANKSET	TEETH
CR-DX8000-OV	SHIMANO® XT-M8000	34T ~ 36T
CR-DX9000-OV	SHIMANO® XTR-M9000	34T ~ 36T



CR-DX009-CM

The evolution of narrow-wide chainrings. This ring can bear a life-time of riding and will never drop with its narrow-wide tooth and Fouriers' snug fit wave design. Additionally each tooth has CNC cut teardrop holes for mud clearance.

Material: Cr-Mo heat treated steel
 P.C.D: Ø104mm
 Weight: 125g/pcs (34T)
 Color: Ti-coating

ITEM	FIX CRANKSET	TEETH
CR-DX009-CM	P.C.D Ø104mm	32T ~ 38T



CR-DX005

The evolution of narrow-wide chainrings. This ring can bear a life-time of riding and will never drop with its narrow-wide tooth and Fouriers' snug fit wave design. Additionally each tooth has CNC cut teardrop holes for mud clearance.

Material: AL7075-T651 full CNC made
 P.C.D: Ø110mm
 Weight: 68g/pcs (38T)
 Color: S.B Anodized Black, Red, Blue

ITEM	FIX CRANKSET	TEETH
CR-DX005	P.C.D Ø110mm	38T ~ 42T



CR-DX006

The evolution of narrow-wide chainrings. This ring can bear a life-time of riding and will never drop with its narrow-wide tooth and Fouriers' snug fit wave design. Additionally each tooth has CNC cut teardrop holes for mud clearance.

Material: AL7075-T651 full CNC made
 P.C.D: Ø130mm
 Weight: 47g/pcs (38T)
 Color: S.B Anodized Black, Red, Blue

ITEM	FIX CRANKSET	TEETH
CR-DX006	P.C.D Ø130mm	38T ~ 42T



ADP-GXP104 ADP-GXP120

Full CNC made spider adapter for P.C.D Ø104 chainring compatible with SRAM® XX1 / X0 / X9 and GXP cranks.

Material: AL7075-T651 full CNC made
 Weight: 56g/pcs
 Color: S.B Anodized Black, Red, Blue

ITEM	FIX CRANKSET
ADP-GXP104	P.C.D Ø104mm
ADP-GXP120	P.C.D Ø120mm



CR-CBE

Full CNC made narrow wide chainring for 1x system.

Material: AL7075-T651
 Weight: 66g (Ø104mm-38T)
 Color: S.B Anodize Black



ITEM	FIX CRANKSET	TEETH
CR-CBE-94	P.C.D Ø94mm	36T ~ 40T
CR-CBE-96	P.C.D Ø96mm	36T ~ 40T
CR-CBE-104	P.C.D Ø104mm	36T ~ 40T
CR-CBE-120	P.C.D Ø120mm	38T ~ 40T
CR-CBE-M8000	SHIMANO® XT-M8000	36T ~ 40T
CR-CBE-M9000	SHIMANO® XTR-M9000	36T ~ 40T

CR-E1-RAFA-OF3 / CR-E1-RAFA-157

Full CNC made narrow wide chainring for 1x System.

Material: AL 7075-T651
 Spe: RaceFace® CINCH System
 Weight: 81g (34T)
 Color: S.B Anodized Black



ITEM	FIX CRANKSET	TEETH
CR-E1-RAFA-OF3	RaceFace® CINCH system + Boost 148 HUB	32T ~ 38T
CR-E1-RAFA-157	RaceFace® CINCH system + Super Boost 157 HUB	38T ~ 42T

CR-E1-GXP12-OF3 / CR-E1-GXP12-157

Full CNC made narrow wide chainring for 1x System.

Material: AL 7075-T651
 Spe: SRAM® GXP System
 Weight: 76g (32T)
 Color: S.B Anodized Black



ITEM	FIX CRANKSET	TEETH
CR-E1-GXP12-OF3	SRAM® GXP system + Boost 148mm HUB	32T ~ 38T
CR-E1-GXP12-157	SRAM® GXP system + Super Boost 157mm HUB	38T ~ 42T

**PREVENT A CHAIN DROP,
PROTECT YOUR FRAME**

AC-DX002-TM

Fouriers chain catcher protects your bottom bracket from chain contact during rigorous riding. Featherweight design with magnet for SRM Powermeter.

Material: AL6061-T6 full CNC made
Range: 34T-50T, 36T-52T, 39T-53T
Weight: 6.5g/pcs (without bolt)
Color: Anodized Black, Red, Gold, Gray, Blue, Apple Green, Orange



AC-DX002-16-L

Fouriers chain catcher protects your bottom bracket from chain contact during rigorous riding. Featherweight design.

Material: AL6061-T6 full CNC made
Range: 34T-50T, 36T-52T, 39T-53T
Weight: 5.5g/pcs (without bolt)
Color: Anodized Black, Red, Gold, Gray, Blue, Apple Green, Orange



AC-S003

Fouriers chain catcher protects your bottom bracket from chain contact during rigorous riding. Featherweight design with carbon wrap.

Material: AL6061-T6 Carbon coating
Range: 34T-50T, 36T-52T, 39T-53T
Weight: 7.5g/pcs (without bolt)



CT-FD007

Seat tube clamp chain guide, prevents the chain from dropping off the upper side.

Material: AL6061-T6
Spec: Ø34.9mm (with Ø31.8mm shim)
Weight: 76g/set
Color: S.B Anodized Black, Black Plastic



CT-FD006-LD

A low-profile, E-type mount low direct mount chain guard for 1X drivetrains. Fully CNC machined body, with a nylon guide that is easy to adjust and quiet on your chain.

Material: AL6061-T6
Spec: 28T-36T
Weight: 20g/set
Color: Anodized Black, Black Plastic



CT-FD002

Seat tube clamp chain guide, prevents the chain from dropping off the upper side.

Material: AL6061-T6
Spec: Ø34.9mm (with Ø31.8mm shim)
Weight: 76g/set
Color: S.B Anodized Black, Black Plastic



CT-FD004-N2-S

A minimalist, direct mount chainguide featuring a full CNC body and a nylon guide. For use with any 1X drivetrain.

Material: AL6061-T6
Spec: Direct mount type guard 30-38T, Suitable for 1x9 1x10 1x11 system speed drive train with plastic upper guard
Weight: 49.5g/set
Color: Anodized Black, Black Plastic



ISCG 05

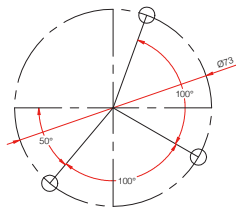

CT-CS001-500

A carbon long fiber body with nylon guide, this minimalist chainguide is a lightweight powerhouse for your 1X drivetrain.

Easy to set up for 30T-36T chainrings.

Material: Carbon with nylon
Spec: ISCG-05
Range: 30T-36T
Weight: 25g/set



ISCG

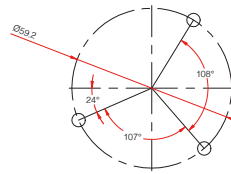

CT-E1-DX001

Robust and economical, this fully encased chainguide keeps your chain fully wrapped around your 1X chainring for the rowdiest conditions.

Material: AL6061-T6
Spec: ISCG or ISCG-05
Range: 32T-40T
Weight: 152g/set
Color: S.B Anodized Black, Red



CT-DX009

Lightweight enclosed chain guide with bash guard. Perfect for 1x system. The redesigned bash guard effectively protects the chainring and easily glides over rocks and obstacles.

Material: AL6061-T6
Spec: ISCG or ISCG-05
Thickness: 5mm
Range: 32T-38T
Weight: 116g/set (Without adapter)
Color: S.B Anodized Black, Red



CT-E1-DX002

Robust and economical, this half-caged chainguide keeps your chain fully wrapped around your 1X chainring for the rowdiest conditions.

Material: AL6061-T6
Spec: ISCG or ISCG-05
Range: 32T-40T
Weight: 169g/set
Color: S.B Anodized Black, Red



CT-DX011-N2

Designed for MTB 1x system drive train. Special design for 28t~32t chainrings to avoid chain drops during heavy use. Simple but effective!

Material: AL6061-T6
Spec: ISCG or ISCG 05
Thickness: 5mm
Size: 28T-32T
Weight: 52g/set
Color: S.B Anodized Black, Red



CT-E1-DX005

A full protection option for your 1X drivetrain. Swiss plastic and AL6061 provide strength and solid impact protection for the most demanding terrain.

Material: AL6061-T6
Spec: ISCG or ISCG-05
Range: 32T-38T
Weight: 220g/set
Color: S.B Anodized Black, Red



CG-DX002

Full CNC light weight bash guard. Protect your chainring with minimal material. For MTB.

Material: AL6061-T6
P.C.D.: Ø104mm
Size: 30T-32T (OD: 147mm)
 34T-36T (OD: 160mm)
 38T-40T (OD: 180mm)
Weight: 85g/set (OD: 160mm)
Color: Anodized Black, Red, Blue

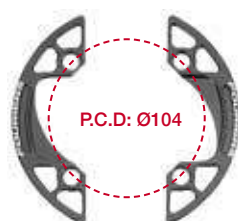

ADP-N001

Adapter for ISCG or ISCG05 to E-type.

Material: AL6061-T6
Spec: Ø59.2mm (ISCG), Ø73mm (ISCG-05)
Weight: 16g/pcs (ISCG), 30g/pcs (ISCG-05)
Color: S.B Anodized Black



ISCG

ISCG-05

FOURIERS & SHIMANO®	System	DURA-ACE				ULTEGRA			
		New				New			
		Model	R9100	R9150 (DI2)	R9000	R9070 (DI2)	R8000	R8000	R8050 (DI2)
		ITEM	RD-R9100-SS	RD-R9150-SS	RD-R9000	RD-R9070	RD-R8000-SS	RD-R8000-GS	RD-R8050
CT-DX007	◎	11T+15T	-	-	MAX 32T	MAX 28T	-	-	-
CT-DX007-H1115	★	11T+15T	-	-	MAX 32T	MAX 28T	-	-	-
CT-DX007-D15-N1	◎	15T+15T	-	-	MAX 28T	MAX 28T	-	-	-
CT-DX007-H1515-N1	★	15T+15T	-	-	MAX 28T	MAX 28T	-	-	-
CT-DX007-HCA-N1	★	12T+16T	-	-	MAX 32T	MAX 25T	-	-	-
CT-DX007-E05-N1	◎	15T+15T	-	-	-	-	-	-	-
CT-DX007-HE05-N1	★	15T+15T	-	-	-	-	-	-	-
CT-DX007-H8050	★	12T+16T	-	-	-	-	MAX 30T	MAX 34T	MAX 32T
CT-DX007-H91-N1	★	12T+16T	MAX 30T	MAX 30T	-	-	-	-	-
CT-DX007-HCA91	★	12T+16T	MAX 30T	MAX 30T	-	-	MAX 30T	MAX 34T	MAX 32T

★ Use full ceramic bearing ◎ Use stainless cone with ceramic bearing

CT-DX007-HCA91

Material: Carbon Cage + AL6061-T6 Cage /
AL7075-T651 pulley
Teeth: 12T + 16T
Weight: 75g
Color: S.B Anodized Black & Carbon cage
Anodized Pulley



CT-DX007-HCA-N1

Material: Carbon Cage / AL6061-T6 Cage /
AL7075-T651 pulley
Teeth: 12T + 16T
Weight: 67g
Color: S.B Anodized Black & Carbon cage
Anodized Pulley



CT-DX007-H91-N1

Material: AL6061-T6 cage &
AL7075-T651 pulley
Teeth: 12T + 16T
Weight: 83g
Color: S.B Anodized Black Cage
Anodized Pulley



CT-DX007-H8050

Material: AL6061-T6 cage &
AL7075-T651 pulley
Teeth: 12T + 16T
Weight: 83g
Color: S.B Anodized Black Cage
Anodized Pulley



CT-DX017-TAPH-N1

Material: AL6061-T6 cage &
AL7075-T651 pulley
Teeth: 15T + 15T
Weight: 82g
Color: S.B Anodized Black Cage
Anodized Pulley



CT-DX017-SRH CT-DX017-SR

Material: AL6061-T6 cage &
AL7075-T651 pulley
Teeth: 15T + 15T
Weight: 92g
Color: S.B Anodized Black Cage
Anodized Pulley



ULTEGRA				105
R6800		R6870 (DI2)	R5800	
RD-R6800-SS	RD-R6800-GS	RD-R6870	RD-R5800	
MAX 32T	MAX 36T	-	-	
MAX 32T	MAX 36T	-	-	
MAX 28T	MAX 36T	-	-	
MAX 28T	MAX 36T	-	-	
MAX 32T	MAX 36T	-	-	
-	-	-	MAX 28T	
-	-	-	MAX 28T	
-	-	-	-	
-	-	-	-	
-	-	-	-	

FOURIERS & SRAM®	System	RED		FORCE	RIVAL
	Model	RED® e-TAP	RED®	Force®	Rival®
	ITEM	RED® e-TAP	RED®	Force®	Rival®
CT-DX017-SR	◎ 15T+15T	-	MAX 28T	MAX 28T	MAX 28T
CT-DX017-SRH	★ 15T+15T	-	MAX 28T	MAX 28T	MAX 28T
CT-DX017-TAPH-N1	★ 15T+15T	MAX 28T	-	-	-

CT-DX007-H1115 CT-DX007

Material: AL6061-T6 Cage & AL7075-T651 pulley
Teeth: 11T + 15T
Weight: 72g
Color: S.B Anodized Black Cage
 Anodized pulley



CT-DX007

CT-DX007-H1115

CT-DX007-H1515-N1 CT-DX007-D15-N1

Material: AL6061-T6 Cage & AL7075-T651 Pulley
Teeth: 15T + 15T
Weight: 84g
Color: S.B Anodized Black Cage
 Anodized pulley



CT-DX007-D15-N1

CT-DX007-H1515-N1

CT-DX007-HE05-N1 CT-DX007-E05-N1

Material: AL6061-T6 Cage & AL7075-T651 pulley
Teeth: 15T + 15T
Weight: 87g
Color: S.B Anodized Black Cage
 Anodized pulley



CT-DX007-E05-N1

CT-DX007-HE05-N1

AC-DX001-C AC-DX001-FC

**Fits SHIMANO® 8, 9, 10, 11 speed
 CAMPAGNOLO® 9, 10, 11 speed**

Material: AL7075-T651 body, AL6061-T6 cap
Bearing: Steel Cone With Ceramic Bearing,
 Full Ceramic Bearing

Teeth: 11T
Weight: 21g/set
Color: Anodized Black, Sliver, Red, Gold, Gray



QR-S007

Heavy duty use quick release for thru-axle system. Full CNC machined carbon with nylon lever can be repositioned by simple lift and lock.

Material: AL7075 axle / Carbon with nylon lever
Spec: Ø12mm axle / 100, 135, 142, 148, 150mm HUB
Weight: 75g - 86g
Color: Anodized Black



	HUB		AXLE	TEETH	NUT
MTB	135	SHIMANO®	168	M12 x 1.75	✓
MTB	142	SHIMANO®	171	M12 x 1.5	✓
MTB	148	SHIMANO®	177	M12 x 1.5	✓
MTB	150	SHIMANO®	183	M12 x 1.75	✓
ROAD	100	-	122	M12 x 1.5	x
ROAD	100	SHIMANO®	118	M12 x 1.5	x
ROAD	142	-	167	M12 x 1.5	x
ROAD	142	SHIMANO®	160	M12 x 1.5	x

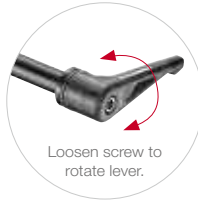

QR-S003

Aluminum full CNC machined axle and lever quick release for thru-axle system.

Material: AL7075 axle / AL7075 lever
Spec: Ø12mm axle / 135, 142, 148, 150mm HUB
 Ø15mm axle with nut
Option: M12 x 1.0mm / M12 x 1.75mm with nut
Weight: 76g/pcs (150mm)
Color: Anodized Black, Red

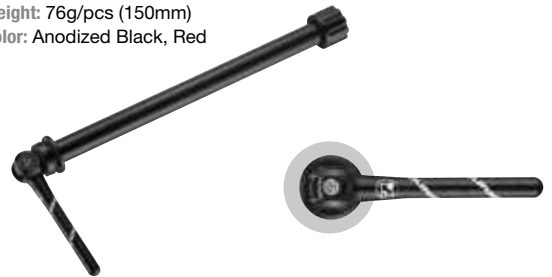

	HUB		AXLE	TEETH	NUT
MTB	135	SHIMANO®	168	M12 x 1.75	✓
MTB	142	SHIMANO®	171	M12 x 1.5	✓
MTB	148	SHIMANO®	177	M12 x 1.5	✓
MTB	150	SHIMANO®	183	M12 x 1.75	✓

QR-E003

QR-type chain hanger and try to avoid your bike crack.

Material: Plastic
Spec: 142, 148, 150mm
Weight: 47g
Color: Black



QR-DX001

Material: Alloy with carbon fiber lever
 Titanium axle ED black finish
Effective Distance: (F)100mm (R)130, 135mm
Weight: 43g/set (ROAD BIKE), 46g/set (MTB)
Color: Anodized Black, Silver, Red, Gold, Gray
 For ROAD BIKE or MTB



QR-S001

Material: Alloy full CNC machined lever
 Titanium axle ED black finish
Effective Distance: (F)100mm (R)130, 135mm
Weight: 45g/set (ROAD BIKE), 47g/set (MTB)
Color: Anodized Black, Silver, Red, Gold, Gray
 For ROAD BIKE or MTB



QR-E001

Material: Alloy lever made anodized finish/10B21 axle
Effective Distance: (F)100mm (R)130, 135mm
Weight: 112g/set (ROAD BIKE), 115g/set (MTB)
Color: S.B Anodized Black, Silver
 For ROAD BIKE or MTB



C-C length \ stem length	80 mm	90 mm	100 mm	110 mm	120 mm	130 mm	140 mm
32mm	○						
42mm	○						
45mm		○	○				
50mm			○	○			
55mm					○	○	
60mm						○	○



HA-S025-DI2

For Campagnolo EPS V3.

Material: Stainless steel
 Angle: 6°
 Weight: 9g
 Color: ED Black



HA-S018-DI2-DIOD2

SHIMANO® DI2 Junction adapter made by CNC. Securely install your Di2 Junction underneath your stem without any zip-ties.
 A simple spacer installation for a clean and professional look.

Material: AL6061-T6 CNC made
 Spe: Ø31.8mm
 C-C Length: 45mm / 55mm
 Angle: 6° & 17°
 Weight: 6g/pcs (45mm)
 Color: S.B Anodized Black, Red, Blue



HA-S018-DI2

SHIMANO® DI2 Junction adapter made by CNC. Securely install your Di2 Junction underneath your stem without any zip-ties.
 A simple spacer installation for a clean and professional look.

Material: AL6061-T6 CNC made
 Spe: Ø28.6mm
 C-C Length: 42mm / 45mm / 50mm / 55mm / 60mm
 Angle: 6° & 17°
 Weight: 6.5g/pcs (42mm)
 Color: S.B Anodized Black, Red, Gray



HA-S018-DI2-8PN

Alloy Aero spacer for SHIMANO® DI2 junction, special design available.
 Fits Pinarello® fork.

Material: AL6061-T6 CNC made
 C-C Length: 50mm
 Angle: 8°
 Weight: 10g/pcs
 Color: S.B Anodized Black

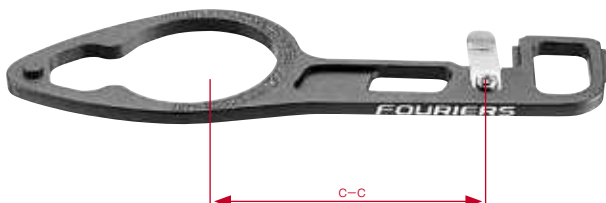

HA-S016-DI2

SHIMANO® DI2 Junction adapter. Securely install your Di2 Junction underneath your stem without any zip-ties.
 A simple spacer installation for a clean and professional look.

Material: Nylon body, AL6061-T6 spacer
 C-C Length: 32mm / 44mm
 Angle: 6° & 17°
 Weight: 7g/pcs (44mm)

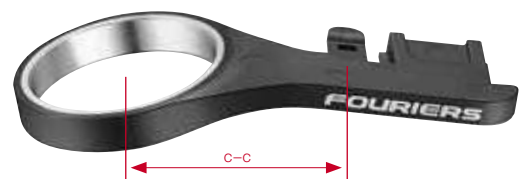



ADP-MOUNT-GIANT

GIANT® NEOSTRACK



ADP-MOUNT-WAHOO

WAHOO® ELEMNT, ELEMNT BOLT, ELEMNT MINI



ADP-MOUNT-MIO

MIO® Cyclo 100, 200, 205, 210, 315, 315HC, 400, 405, 405HC, 500, 505, 505HC, 605HC

COMPUTER MOUNT

Change freely, compatible with all major brands.



ADP-MOUNT-BRYTON

BRYTON® 530, 330, 310, 100



ADP-MOUNT-GARMIN

GARMIN EDGE® 1030, 1000, 820, 520, 200



HA-S024-3CA

Special for 2018 new GIANT® PROPEL STEM, compatible with GARMIN Edge® & MIO® & Bryton®.

Material: AL6061-T6 body, plastic adapter
Weight: 38.5g/set
Color: S.B Anodized Black



HA-S026-3CA

Steerer tube type cycling computer mount.

Material: AL6061-T6
Spec: Ø28.6
Thickness: 7mm
Angle: -6°
Weight: 19g
Color: Anodized Black



HA-S022-4CA-N2

For stem front cap. Compatible with GARMIN Edge® & MIO® & GoPro® & Bryton®.

Material: AL6061-T6
Screw Center Distance: 23 - 40mm
Angle Adjustable: ±20°
Weight: 42g/set
Color: S.B Anodized Black



HA-S014

For stem front cap. Compatible with GARMIN Edge® & MIO® & GoPro® & Bryton®.

Material: AL6061-T6 body, plastic adapter
Screw Venter Distance: 9 - 33mm
Weight: 42g/set
Color: S.B Anodized Black



HA-GAMPR12

Compatible with GARMIN Edge® & MIO® & GoPro® & Bryton®.
For Ø31.8 handlebar.

Material: AL6061-T6 body, plastic adapter
Weight: 56g/set
Color: S.B Anodized Black, Red, Gray



HA-S017-N2

Compatible with GARMIN Edge® & MIO® & Bryton®.
For Ø31.8 handlebar. Arm length adjustable.
With Ø31.8 x Ø25.4 shim & Ø31.8 x Ø22.2.

Material: AL6061-T6 body, plastic adapter
Weight: 43g/set
Color: S.B Anodized Black, Red, Gray



HA-S029

Special designed for GIANT® Contact SLR. Aero Integrated Handlebar & Stem. Compatible with GARMIN Edge® & MIO® & GoPro® & Bryton®.

Material: AL6061-T6 body & Plastic mount
Weight: 40g
Color: S.B Anodized Black



HA-S023-TT

Compatible with GARMIN Edge® & MIO® & Bryton®.
For triathlon arm rest tube Ø22.2.

Material: AL6061-T6 body, plastic adapter
Weight: 48g/set
Color: S.B Anodized Black





CONVENIENCE GoPro® MOUNT SYSTEM

HA-GP04

Saddle rail mount for GoPro® interface device.
Fits all standard two rail saddles.

Material: AL6061-T6
Weight: 63g
Color: S.B Anodized Black



HA-GP05

Compatible with Garmin Edge® interface, for GoPro® mount.

Material: Plastic
Weight: 10g
Color: Black



HA-S020-GMSP

Sport camera GoPro® mount on seatpost.
Record exciting ride video behind you.

Material: AL6061-T6
Clamp: Ø31.6mm (with shim Ø27.2mm)
Weight: 39g/set
Color: S.B Anodized Black



HA-GP01-X2

Convert GoPro® mount into double mounts.

Material: AL6061-T6
Weight: 29g/set
Color: S.B Anodized Black

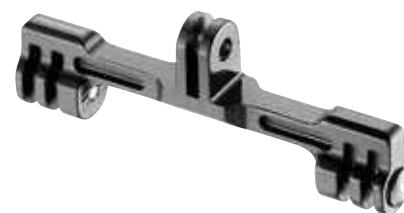

HA-GP02-LT

GoPro® mount convert to light holder.

Material: AL6061-T6
Weight: 17g/set
Color: S.B Anodized Black



HA-GP03

GoPro® mount convert extension arm.

Material: AL6061-T6
Weight: 49g/set
Color: S.B Anodized Black



HA-S002

For Ø31.8mm, Ø35mm handlebar.
Ø26 Carbon tube for computer mounting.

Material: AL6061-T6
Spec: Ø31.8, Ø35mm
Weight: 34g



HA-WM001

Special mount for sport watch.
Attach it to restbars and keep a close eye on
your performance.

Material: AL6061-T6
Clamp: Ø22.2mm
Weight: 60g/set
Color: S.B Anodized Black



HA-WA002

Special mount for sport watch.
Attach it to handlebars and keep a
close eye on your performance.

Material: AL6061-T6
Clamp: Ø31.8mm
Weight: 82g/set
Color: S.B Anodized Black



HA-S015-SRM8-N2

Compatible with SRM® Power Control 8.
For Ø31.8 handlebar.

Material: AL6061-T6
Clamp: Ø31.8mm
Weight: 38.5g/set
Color: S.B Anodized Black



ADP-STK01-GARMIN

Compatible with Garmin® computer mount.
Use 3MVHB tape to fit on device cover.

Material: Polycarbonate
Weight: 10g
Color: Black



ADP-MOUNT-CAR

Garmin® computer mount with steel plate.
Put on your smart phone soon and easy in car when you use
ADP-STK01-GARMIN on your smartphone.

Material: Nylon & Stainless steel
Weight: 11g
Color: Black



HB-TR003

Fixed arm pads. Arm rest height adjustable with 20-60mm adapter.

Material: AL6061-T6 Body
Carbon or AL6061-T6 Tube

Weight: 470g/set
Triathlon arm rest
For Ø31.8 handlebar



Comes with an adapters to change the height



HB-TR003-101

With Alloy S tube (HB-TUB-101)
Angle 17° / 340mm



HB-TR003-101C

With Carbon fiber S tube (HB-TUB-101C)
Angle 17° / 340mm



HB-TR003-201

With Alloy J1 tube (HB-TUB-201)
Angle 17° / 310mm



HB-TR003-201C

With Carbon fiber J1 tube (HB-TUB-201C)
Angle 17° / 310mm



HB-TR003-301

With Alloy J2 tube (HB-TUB-301)
Angle 50° / 300mm



HB-TR003-301C

With Carbon fiber J2 tube (HB-TUB-301C)
Angle 50° / 300mm



HB-TR003-401

With Alloy JS tube (HB-TUB-401)
Angle 17° / 180mm



HB-TR003-401C

With Carbon fiber I tube (HB-TUB-401C)
Angle 0° / 300mm



HB-TR002

Triathlon tri-bar bridge. Has an adjustable width to a maximum of 105mm. Also features a Ø26mm computer mount bar for your convenience.

Material: Nylon
Width: 85mm - 105mm
Weight: 54g/set



For Triathlon bar bridge

WBC-DX001

Water bottle cage adapter for triathlon bar. Simple and effective.

Material: AL6061-T6
Weight: 30g/pcs
Color: S.B Anodized Black



Clamping the water bottle cage
For Triathlon bar

ADP-TRI-PLM10 / ADP-TRI-PLM15

For SCOTT PLASMA® rest bar, adjustable your armrest pad angle.

Material: AL6061-T6
Angle: 10° & 15°
Weight: 48g/set
Color: S.B Anodized Black



ADP-TRI-BD10 / ADP-TRI-BD15

For GIANT® Trinity aerodrive rest bar, adjustable your extension Bar & Pad.

Material: AL6061-T6
Angle: 10° & 15°
Weight: 117g/set
Color: S.B Anodized Black



ADP-TRI-HB10 / ADP-TRI-HB15

For GIANT® Trinity aerodrive rest bar, adjustable your armrest pad angle.

Material: AL6061-T6
Angle: 10° & 15°
Weight: 43g/set
Color: S.B Anodized Black



WBC-TT003

For GIANT® 2016 Trinity aerodrive rest bar bridge. increase rigidity when use a higher rest bar

Material: AL7075-T651
Width: 120 / 142mm
Weight: 30g/pcs
Color: S.B Anodized Black



Increase rigidity when use a higher rest bar



***Take Your Journey In The
Colours Of Your Imagination***



FOR ALL WEATHER CONDITIONS COMFORTABLE HANDING

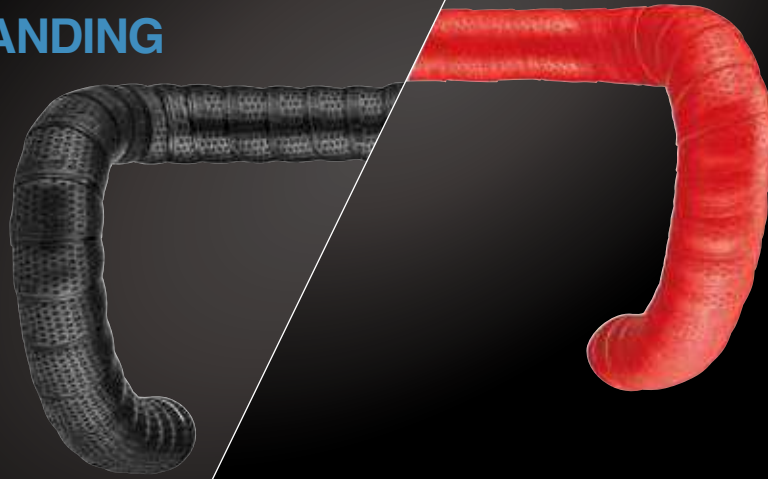

BP-S003-Q

The new surface of round dot pattern and the evolution of new polyurethane foam material provide better slip-resisting effect and comfortable handling, not only for all weather conditions but also for an excellent handling experience.

Material: PU
Spec: 3 x 210cm
Thickness: 3.0mm
Color: Black, Red, Dark Blue, White



BP-S002-W

Bar tape with the latest design PU material for better and more comfortable grip in any weather condition.

Material: PU
Spec: 3 x 210cm
Thickness: 3.0mm
Color: Black, Red, Blue, Apple Green, Pink, White, Yellow, Tiffany Green, Light Blue, Fluorescent Pink



GP-S001

Ultra comfortable silicone material provides the rider with uncompromising grip. Relieve hand tension and remain in control. The dimpled surface provides a cooling space as your hands begin to sweat.

Material: Silicone rubber foam
Spec: Ø30 x 130mm / Ø32 x 130mm
Color: Black, Red, Blue, Apple Green, Orange, Pink, White, Yellow



BP-S001

Bar tape with the latest design PU material for better and more comfortable grip in any weather condition.

Material: PU
Spec: 3 x 210cm
Thickness: 3.0mm
Color: Black, Carbon Black, Red, Blue, Apple Green, Pink, Carbon White, Yellow, Tiffany Green, Light Blue, Fluorescent Pink



AC-PG002-MB

Screw on plugs for handlebar cap, gives a secure hold to all tapes and grips. For handlebar ID: Ø17-21mm. 2 pieces a set.

Material: Alloy cap with stainless bolts
Weight: 41g/set
Color: Black, Silver, Red, Gold, Blue, Pink, Apple Green, Orange



AC-PGN03-MB

Screw on plugs for handlebar cap, gives a secure hold to all tapes and grips. For handlebar ID: Ø17-21mm. 2 pieces a set.

Material: Plastic plug with alloy bolts
Weight: 24g/set
Color: Nylon Black



AC-PG001-RC

Handlebar plugs to tightly secure the bar tape and grip. For handlebar ID: Ø17-21mm. Comes in 2 pieces a set.

Material: Plastic plug with alloy bolts
Weight: 20g/set
Color: Nylon Black



WBC-BE004-P

Bottle incorporates Jet Valve, a revolutionary self-sealing valve, into a spill and splatter free bottle.

Material: PP

Range: 600cc

Weight: 54g/pcs

Color: Black, Red, Blue, Apple Green, Orange, Pink, White, Transparent, Yellow, Sky Blue, Tiffany Green, Purple, Transparent Black



WBC-BE006-CA

Bottle incorporates Jet Valve, a revolutionary self-sealing valve, into a spill and splatter free bottle.

Material: PP

Range: 600cc

Weight: 48g/pcs

Color: Black, Red, Blue, Apple Green, Orange, Pink, White, Transparent, Yellow, Sky Blue, Tiffany Green, Purple, Transparent Black



WBC-BE005-E

Normal Valve version.

Material: PP

Range: 600cc

Weight: 56g/pcs

Color: Black, Red, Blue, Apple Green, Orange, Pink, White, Transparent, Yellow, Sky Blue, Tiffany Green, Purple, Transparent Black



WBC-S001

Special designed aero dynamic water bottle cage.

Cages includes the water bottle. L size can hold up to 600cc and S size 300cc of water.

Material: Carbon UD cage + Plastic water bottle

Volume: (L) 600cc (S) 300cc

Weight: (L) 82.5g/pcs

(S) 62.5g/pcs

(CAGE) 26g/pcs



WBC-DX004-C500

Advanced carbon fiber injection technology forms beautiful lines at a competitive price. Stiff carbon arms keep your bottle locked in place.

Material: Carbon with Nylon

Weight: 29.5g/pcs

Color: UD with white sticker, UD with white/red sticker



WBC-S004

Molded plastic arms provide smooth entry and exit of your bottles, while keeping them locked in place.

Material: Plastic

Weight: 46g/pcs

Color: Black, Red





SCL-S005-CA

Seatclamp with a rubber dust cover to protect your frame from dust creeping into your seat tube. Chamfered edge & oval clamping mechanism to protect carbon frames & seatpost.

Material: AL6061-T6 clamp with NBR cover
Spec: Ø31.8mm / Ø34.9mm
Height: 16mm
Weight: 25g (Ø31.8mm) / 28g (Ø34.9mm)
Color: Clamp: S.B Anodized Black
 Cover: Black, Red, Blue, Appne Green, Orange, Pink, White, Yellow

SCL-S006-CA

Extra security to prevent your seatpost from slipping past your seatclamp. Keeps your seat height consistent, and the dust out of your seat tube. Can be used with any seatclamp.

Material: AL6061-T6 clamp with NBR cover
Spec: Ø27.2, Ø30.9, Ø31.6mm
Height: 8.5g-11g/set
Color: Clamp: S.B Anodized Black
 Cover: Black, Red, Blue, Apple Green, Orange, Pink, White, Yellow



SCL-DN001

Special nut design allows screw to automatically adjust its angle to prevent deformation caused by tightening the seat clamp too much.

Material: AL6061-T6
Spec: Ø31.8, Ø34.9mm
Height: 14mm
Weight: 17.5g/set (Ø31.8mm)
 18.5g/set (Ø34.9mm)
Color: Anodized Black



SCL-S001

Double M5 bolt. Chamfer edge & oval hole design to protect carbon frames & seatposts. Rubber cover helps prevent dust and water from getting into the seat tube.

Material: AL6066-T6
Spec: Ø31.8, Ø34.9mm
Height: 17.5mm
Weight: 24g/set (Ø31.8mm)
 27g/set (Ø34.9mm)
Color: Anodized Black, Silver, Red, Gold, Gray



SCL-E001

Special nut design allows screw to automatically adjust its angle to prevent deformation caused by tightening the seat clamp too much.

Material: AL6061-T6
Spec: Ø31.8, Ø34.9mm
Height: 11mm
Weight: 22.5g/set (Ø31.8mm)
 23.5g/set (Ø34.9mm)
Color: Anodized Black, Silver



SCL-QX002

Seat clamp with ultra-lightweight and sleek quick release. Chamfer edge & oval hole design to protect carbon.

Material: AL6061-T6
Spec: Ø31.8, Ø34.9mm
Height: 16mm
Weight: 26g/set (Ø31.8mm)
 29g/set (Ø34.9mm)
Color: Anodized Black, Silver, Red, Gold, Gray



SCL-QE001

Special seat clamp with a screw that can't be disassembled for the security of your seat post installation.

Material: AL6061-T6
Spec: Ø31.8, Ø34.9mm
Height: 13.5mm
Weight: 110g/set (Ø31.8mm)
 113g/set (Ø34.9mm)
Color: S.B Anodized Black, Silver



HA-S005

For Ø28.6 carbon fork inner tube expander. Protect carbon fork tube from over tightening.

Material: AL6061-T6 with Alloy top cap

Spec: Fit ID Ø22.0 - Ø25.0 fork

Length: 50mm

Weight: 62g/set

Top Cap Color: Anodized Black, Silver, Red, Gray, Gold



HA-S007

Comes with long screw, top cap and spacers.

Material: AL6061-T6 body, Top cap, Spacer

Length: 50mm (Adjust height 47.5mm - 65.5mm)

90mm (Adjust height 47.5mm - 105.5mm)

120mm (Adjust height 47.5mm - 135.5mm)

Weight: 154g-230g/set



HA-S008

Integrated headset system.

Angle contact seal bearing.

Material: Top cover AL6061-T6

Spec: Integrated 1-1/8" Upper/1.5" Bottom

(UP) Ø28.6 x Ø41.8mm / (DOWN) Ø39.5 x Ø51.8mm

Cone Spacer Height: 15mm

Bearing: (UPPER) 41.8 x 45° x 8

(LOWER) 51.8 x 45° x 8

Weight: 78g/set

Color: S.B Anodized Black



HA-S008-H8

Integrated headset system.

Angle contact seal bearing.

Material: Top cover AL6061-T6

Spec: Integrated 1-1/8" Upper/1.5" Bottom

(UP) Ø28.6 x Ø41.8mm / (DOWN) Ø39.5 x Ø51.8mm

Cone Spacer Height: 8mm

Bearing: (UPPER) 41.8 x 45° x 8

(LOWER) 51.8 x 45° x 8

Weight: 74g/set

Color: S.B Anodized Black



HA-S001

Canti Brake cable hanger.

Carbon spacer can reduce brake noise.

For Ø28.6 fork tube.

Material: Carbon 3K

Height: 4mm

Weight: 29g/set



SR-S003

Set of 3 spacers: 5mm x 2pcs, 10mm x 1pcs.

Material: Transparent Nylon

Diameter: ID Ø28.6 x OD Ø36mm

Weight: 7.2g/set

Color: White, Blue, Orange, Light Orange, Green, Transparent, Light Pink, Purple, Yellow



SR-S001

Set of 4 spacers: 3, 5, 10mm, Taper Spacer.

Material: Carbon 3K & AL6061-T6 (Taper Spacer)

Diameter: ID Ø28.6 x OD Ø34mm

Weight: 11g/set



SR-S002

Ultra lightweight spacer.

Set of 4 spacers: 3, 5, 10mm, Taper Spacer.

Material: Carbon 3K & AL6061-T6 (Taper Spacer)

Diameter: ID Ø28.6 x OD Ø34mm

Weight: 9g/set



SR-E001

Set of 4 spacers: 3, 5, 10mm, Taper Spacer.

Material: AL6061-T6

Diameter: ID Ø28.6 x OD Ø36mm

Weight: 16g/set

Color: Anodized Black, Silver, Red, Gold, Gray



SR-E002

Ultra lightweight spacer.

Set of 4 spacers: 3, 5, 10mm, Taper Spacer.

Material: AL6061-T6

Diameter: ID Ø28.6 x OD Ø36mm

Weight: 11g/set

Color: Anodized Black, Silver, Red, Gold, Gray



TC-DX018 / TC-DX018-OD2

Material: AL6061-T6 / Stainless bolts
 Spec: Fit 1-1/8 or 1-1/4 fork
 Weight: 4g/pcs



A011



A012



A013



A031



A041

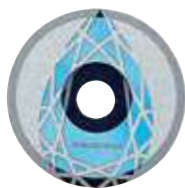

A061



A121

TC-DX012

Material: AL6061-T6 / Stainless bolts
 Spec: Fit 1-1/8 fork
 Weight: 15g/pcs
 Color: Ti-Coating



TC-S001

Material: AL6061-T6 / Stainless bolts
 Spec: Fit 1-1 / 8 fork
 Weight: 23g/pcs
 Color: Anodized Black



TC-S002

Material: Carbon / Stainless bolts
 Spec: Fit 1-1 / 8 fork
 Weight: 12g/pcs
 Color: 3K



TC-E001 / TC-S004 / TC-S005 / TC-S006 / TC-S007

Material: AL6061-T6 / Stainless bolts
 Spec: Fit 1-1/8 fork
 Weight: 15g/pcs



TC-E001



TC-S004



TC-S005



TC-S006



TC-S007

VL-PE004

1 set = 2pcs

Material: AL6061-T6

Spec: Presta valve

Weight: 3g/set

Color: Anodized Black, Sliver, Red, Gold, Gray, Blue, Apple Green, Orange



VL-PE009

1 set = 2pcs

Material: AL6061-T6

Spec: Presta valve

Weight: 1g/set

Color: Anodized Black, Sliver, Red, Gold, Gray



VL-PE006

Double teeth for Presta & USA valve.
1set =2pcs

Material: AL6061-T6

Spec: Presta valve & USA valve

Weight: 7g/set

Color: Anodized Black, Sliver, Red, Gold, Gray



VL-US003

1 set = 2pcs

Material: AL6061-T6

Spec: Presta change to USA valve

Weight: 2.3g/set

Color: Anodized Black, Sliver, Red, Gold, Gray



VL-US001

1 set = 2pcs

Material: AL6061-T6

Spec: USA valve

Weight: 18.7g/set

Color: Anodized Black, Sliver, Red, Gold, Gray



VL-US002

1 set = 2pcs

Material: AL6061-T6

Spec: USA valve

Weight: 13g/set

Color: Anodized Black, Sliver, Red, Gold, Gray



BN-M003

1 set = 2pcs

Material: AL7075-T651

Spec: M5 x 0.8mm

Length: 17mm

Weight: 2.6g/set

Color: Anodized Black, Sliver, Red, Gold, Gray, Blue, Apple Green, Orange, Purple, Green



BN-M002

1 set = 2pcs

Material: AL7075-T651

Spec: M5 x 0.8mm

Length: 10mm

Weight: 2.6g/set

Color: Anodized Black, Sliver, Red, Gold, Gray, Blue, Apple Green, Orange, Purple, Green



BN-M001

1 set = 5 pair

Material: AL7075-T651

Spec: M8 x 0.75mm

Length: 5mm, 7mm

Tool: Allen wrench 5mm

Weight: 10g/set

Color: Anodized Black, Sliver, Red, Gold, Gray, Blue, Apple Green, Orange, Purple, Green



VL-TUS-F

Tubeless valve. Comes with valve core, cap and tool.

Material: AL6061-T6 / Nylon cap and tool
 Spec: Presta
 Length: 40, 60mm
 Weight: 9g/set (40mm)
 Color: Anodized Black



VL-AMTUS-F

Tubeless valve. Comes with valve core, cap and tool.

Material: AL6061-T6
 Spec: USA
 Length: 40mm
 Weight: 13g/set
 Color: Anodized Black

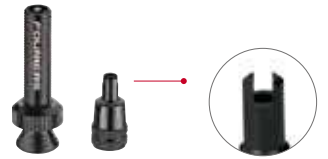

VL-PE001

Presta valve extender CNC Machined, 1set = 2pcs.

Material: AL6061-T6
 Length: 25, 38, 50, 60, 70, 80, 90, 100mm
 Weight: 8g/set (60mm)
 Color: Anodized Black, Silver



VL-PE002

Presta valve extender, 1set = 2pcs.

Material: AL6061-T6
 Length: 20, 30, 40, 50, 60, 70, 80, 90, 100mm
 Weight: 7.5g/set (60mm)
 Color: Anodized Black, Silver



VL-PE003

Presta valve extender. Only for VITTORIA® tubular tire, 1set = 2pcs.

Material: AL6061-T6
 Length: 30, 40, 50, 60, 70mm
 Weight: 9g/set (60mm)
 Color: Anodized Black, Silver

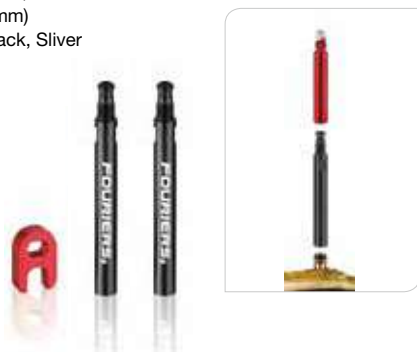

VL-PE007

Tire Valve Extensions: Simple, air-tight installation without tape or threadseal, while reducing noise and vibration on the road. 1set = 2pcs.

Material: AL6061-T6 Body, Nylon Ring
 Length: 38, 50, 60, 70, 80, 90, 100mm
 Weight: 6.5g/set (60mm)
 Color: Anodized Black



VL-PE008-N

Tubeless valve (removable type) extender, can easily fixed by outer thread & nut. 1set = 2pcs.

Material: AL6061-T6
 Length: 40, 60mm
 Weight: 8g/set (60mm)
 Color: Anodized Black



VL-PE005

Disc wheel 90 degree adapter. Fix Presta valve rim tire.

Material: AL6061-T6 CNC made
 Weight: 9.6g/pcs
 Color: Anodized Black

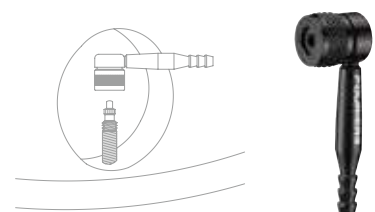

ADP-HB701-AS

Carbon fiber and nylon, in-board extensions for your grip. Ergonomically designed to give relief by an additional hand position for long days behind the handlebars. Your fingers have greater mobility and are free to work the brakes.

Material: Carbon fiber with special nylon
Spec: Diameter Ø22.2mm
Weight: 17.8g/set



PEG-CH001

Special peg for kids's BMX, short length.

Material: AL6061-T6
Spec: Ø28 x 75mm
Weight: 55g/pcs
Color: Anodized Black, Silver, Red, Gold, Gray, Blue, Apple Green, Orange, Purple



ADP-WCO

CO2 mount for water bottle cage hole.

Material: AL6061 full CNC made
Weight: 19g
Color: S.B Anodized Black



AC-S007

A lightweight seatpost shim to fit your seatpost in an oversized seat tube.

Material: AL6061-T6
Spe: Ø31.6 x Ø30.9mm
Ø31.6 x Ø27.2mm
Ø30.9 x Ø27.2mm
Length: 90mm
Weight: 9g/pcs (Ø31.6 x Ø30.9mm)
46g/pcs (Ø31.6 x Ø27.2mm)
38g/pcs (Ø30.9 x Ø27.2mm)
Color: Anodized Black, Silver



ADP-BOC-C500

Lamp peg & Rear derailleur protector. For Front & Rear Wheel.

Material: Carbon 3K Body & AL6061 Cap
Spec: M5 x 0.8mm
Weight: 25g/pcs
Color: Carbon 3K



ADP-BOT-A011

Lamp peg for front wheel.

Material: AL6061-T6
Spec: M5 x 0.8mm
Weight: 36g/pcs
Color: S.B Anodize Black



AC-S002

Adapter for bar bore, available in 3 sizes. Carbon fiber has damping capacity to reduce vibration during riding.

Material: Carbon UD
Spec: Ø35 x Ø31.8mm, Ø31.8 x Ø26mm, Ø31.8 x Ø25.4mm
Width: 60mm
Weight: 24g/set (Ø31.8 x Ø25.4mm)



AC-S001

Adapter for the fork tube Ø31.8mm to Ø28.6mm.

Material: Carbon UD
Spec: Ø31.8 x Ø28.6mm
Length: 38mm
Weight: 10g/pcs



AC-A002

Adapter for bar bore Ø35mm to Ø31.8mm.

Material: AL6061
Spec: Ø35 x Ø31.8mm
Width: 60mm
Weight: 20g/set



AC-A001

Adapter for the fork tube Ø31.8mm to Ø28.6mm.

Material: AL6061
Spec: Ø31.8 x Ø28.6mm
Length: 38mm
Weight: 15g/pcs



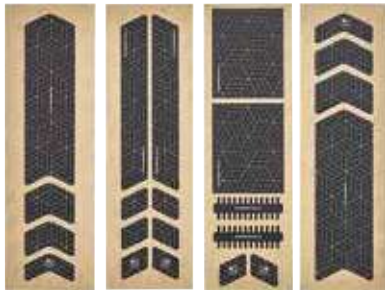

AC-S009

The function of protector is to provide the best Friction resistance and protection for the frame, it keeps your frame new and clean.

Material: PVC

Spec: Top tube protection x 1
Down tube protection x 1
Chainstay protection x 2
Frame or other protection x 6

Weight: 31g

AC-MG004-F

Front mudguard to keep your fork and your face free from dirt and debris.

Customizable cut lines on the under side of the guard.

We use eco-friendly and recyclable PP (polypropylene) material.

Material: Polypropylene (PP)

Thickness: 1.2mm

Weight: 37g/pcs

Color: Black



AC-MG005-R

Assemble on saddle rail.

We use eco-friendly and recyclable PP (polypropylene) material.

Smart-Fix aonstruction for quick removal.

Material: Polypropylene (PP)

Thickness: 1.2mm

Weight: 30g/pcs

Color: Black



AC-MG001-N2

Assemble on MTB suspension fork.
Not available in Europe.

Material: Polypropylene (PP)

Thickness: 0.8mm

Weight: 28g/pcs

Color: Black, Apple Green, Orange,
Pink, White, Yellow



AC-MG002-R

Assemble on saddle rail.
Not available in U.S.A.

Material: Polypropylene (PP)

Thickness: 0.8mm

Weight: 19g/pcs

Color: Black, Apple Green, Orange,
Pink, White, Yellow



AC-S005

Anti-puncture frame protector roll.

Material: PU

Spec: W100 x L1500mm (AC-S005-100)

Weight: 110.5g/pcs (AC-S005-100)

8g/pcs (AC-S005-002)

15g/pcs (AC-S005-012)



AC-S005-100



AC-S005-002

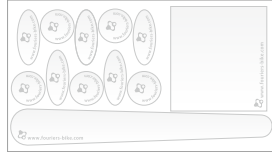

AC-S005-012

AC-S006

Puncture protection tape.

Material: PU

Spec: W20 x L2090mm (Road)

W31 x L2350mm (MTB)

Weight: 37.5g/pcs (Road)

71.5g/pcs (MTB)



TL-ST060-17P

18 function bike tool set.

Hex 2 / 2.5 / 3 / 4 / 5 / 6 / 8mm, PH2, SL4, T25.

Spoke wrench SHIMANO® 4.3 / 4.4 / Hex4.6 / MAVIC M7.

Bottle opener Chain breaker (9 / 10 / 11 speed) Tire lever.

Material: Chrome Vanadium with durable Matte
Chrome plating tool & AL6061-T6 cage

Weight: 178g/set

Color: Frame - Black, Red, Gray, Blue,
Apple Green, Orange, Purple, Pink



TL-ST41-6P

6 function bike tool set.

Hex 3 / 4 / 5 / 6mm, PH2, T25.

Material: Chrome Vanadium with durable Matte
Chrome plating tool & AL6061-T6 cage

Weight: 75g/set

Color: Frame - Black, Red, Gray, Blue,
Apple Green, Orange, Purple, Pink



TL-ST42-8P

8 function bike tool set.

Hex 2 / 2.5 / 3 / 4 / 5 / 6mm, PH2, T25.

Material: Chrome Vanadium with durable Matte
Chrome plating tool & AL6061-T6 cage

Weight: 83g/set

Color: Black, Red, Gray, Blue, Apple Green,
Orange, Purple, Pink

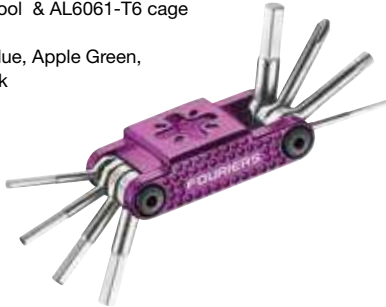

TL-ST001

9 function bike tool set.

Hex 1.5, 2, 2.5, 3, 4, 5, 6, 8, 10mm.

Material: Heat treatment steel 6150 tool
Nylon body

Weight: 385g/set

Color: CP



TL-S001

3 function bike tool set.

Hex 4, 5, 6mm.

Material: Heat treatment steel 6150 tool
Nylon body

Weight: 65mm, 80mm

Color: Black, Red, Gray, Blue,
Fluorescent Green



TL-S003-1544

Lock ring tool with clean lines
to blend in with your bike. Store
on the water bottle braze-ons,
or comfortably in your back
pocket.

Material: Hardened stainless steel
High polish finished

Spec: 15mm nut / lock ring (OD Ø42 - Ø44)

Weight: 80g/pcs

Color: Polish





FOURIERS

www.fouriers-bike.com